

Z
(2:1)

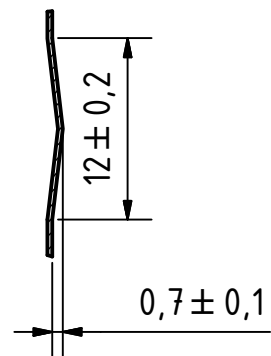

X
(5:1)

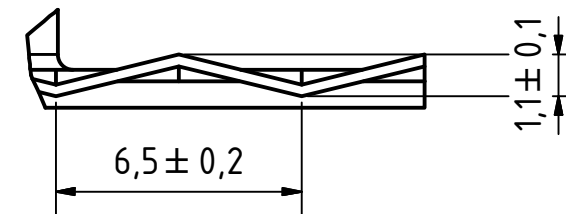

A-A
(1:1)

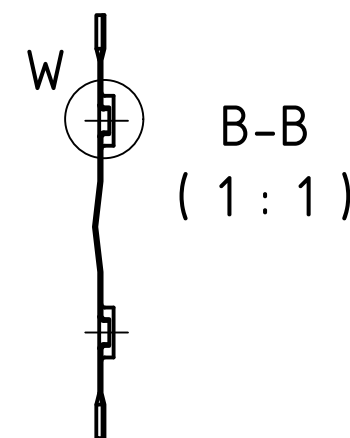
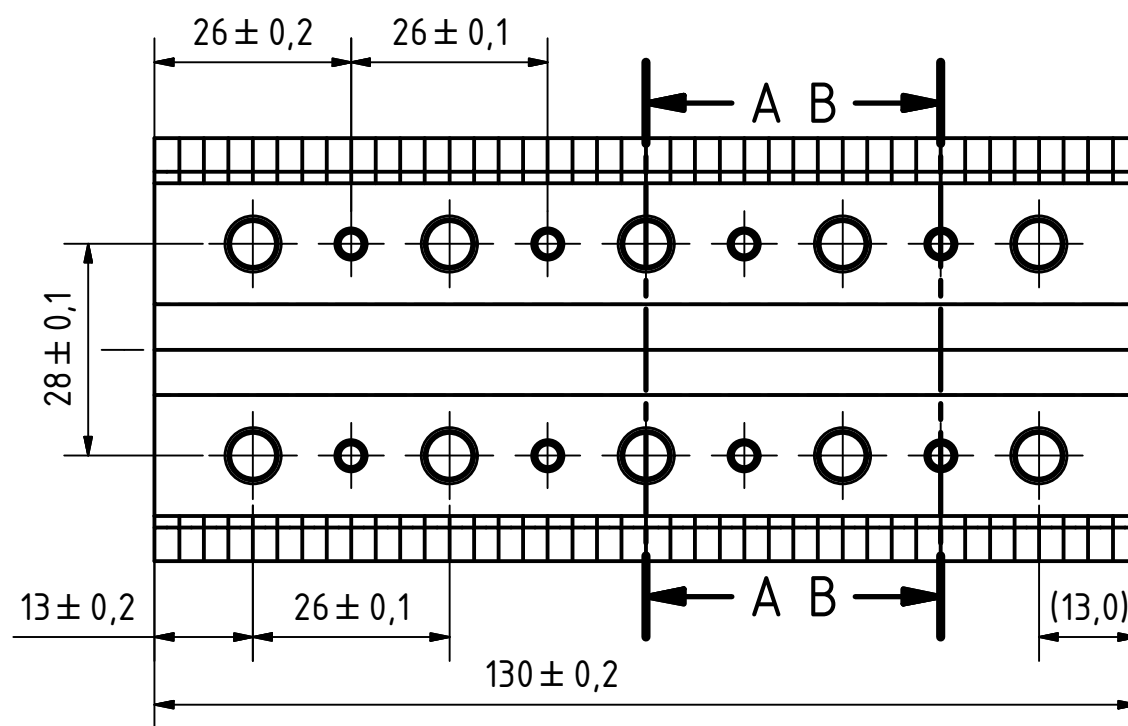
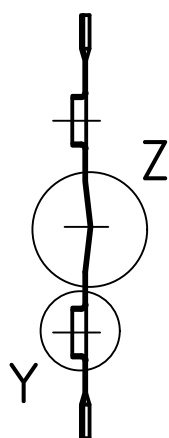

B-B
(1:1)

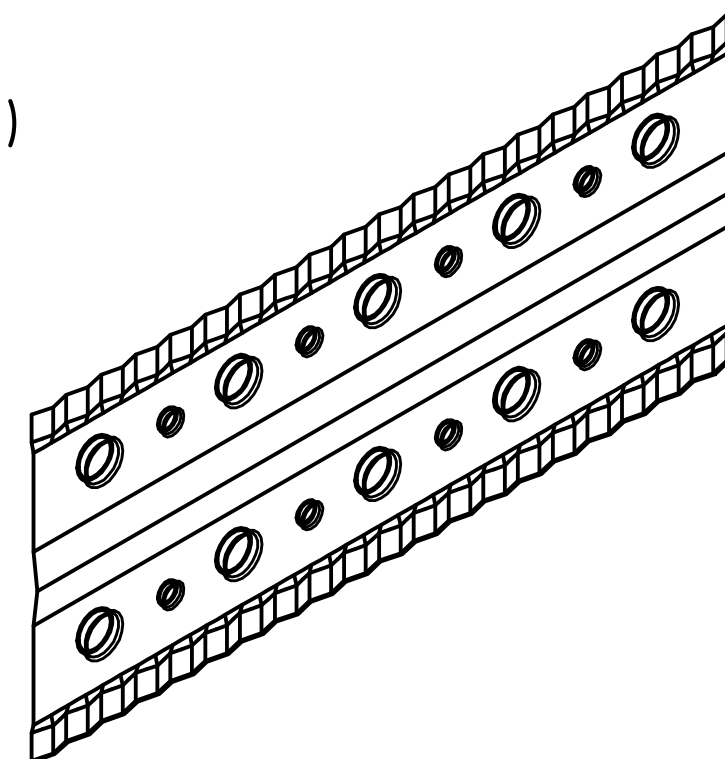

Y
(5:1)

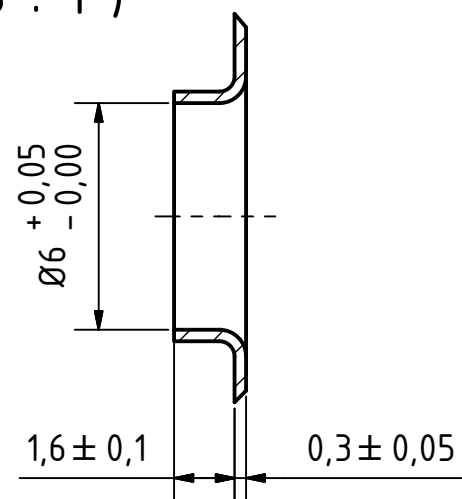

W
(5:1)

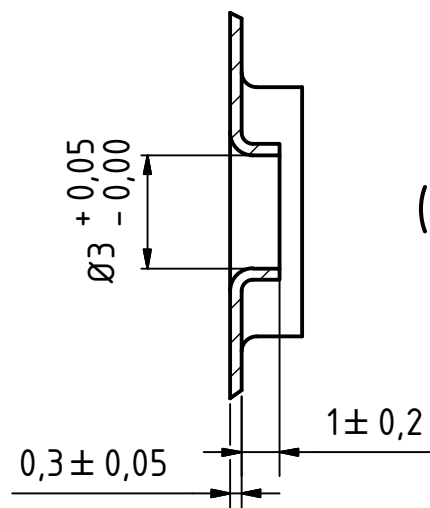

Allgemein-toleranzen DIN ISO 2768-mH		Massstab : 1:1	Gewicht : 0,01 kg
		Firma : Quick-Ohm	
Gezeichnet	Datum	Material : Aluminium - 6061	
Kontrolliert	Name	Zeichnungs-Nr : AlMgSi0.5	
Norm			
 <small>Kitpper & Co. GmbH</small>		Fin_130x56xD6	1
			A3
Status	Änderungen	Datum	Name